



BRACHYDOSE

**Helps to prevent cancer treatment errors**

Neringa Šeperienė, Co-Founder CEO



**200 mn**

**Patients in  
EU, US**

**80%**

**Error  
incidence  
rate**

# Future of cancer treatment

## 1 Disposable sensor

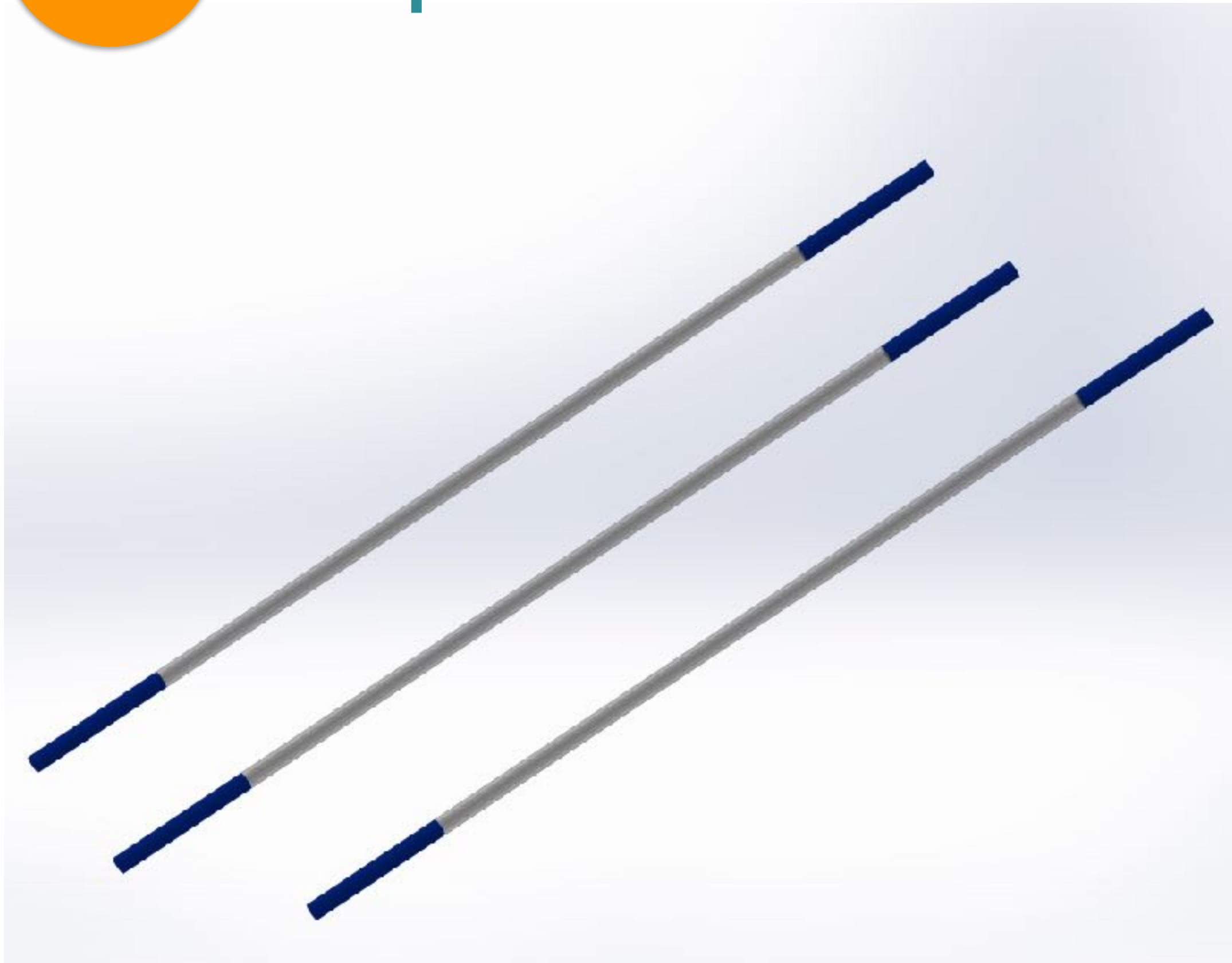

## 2 Data collection

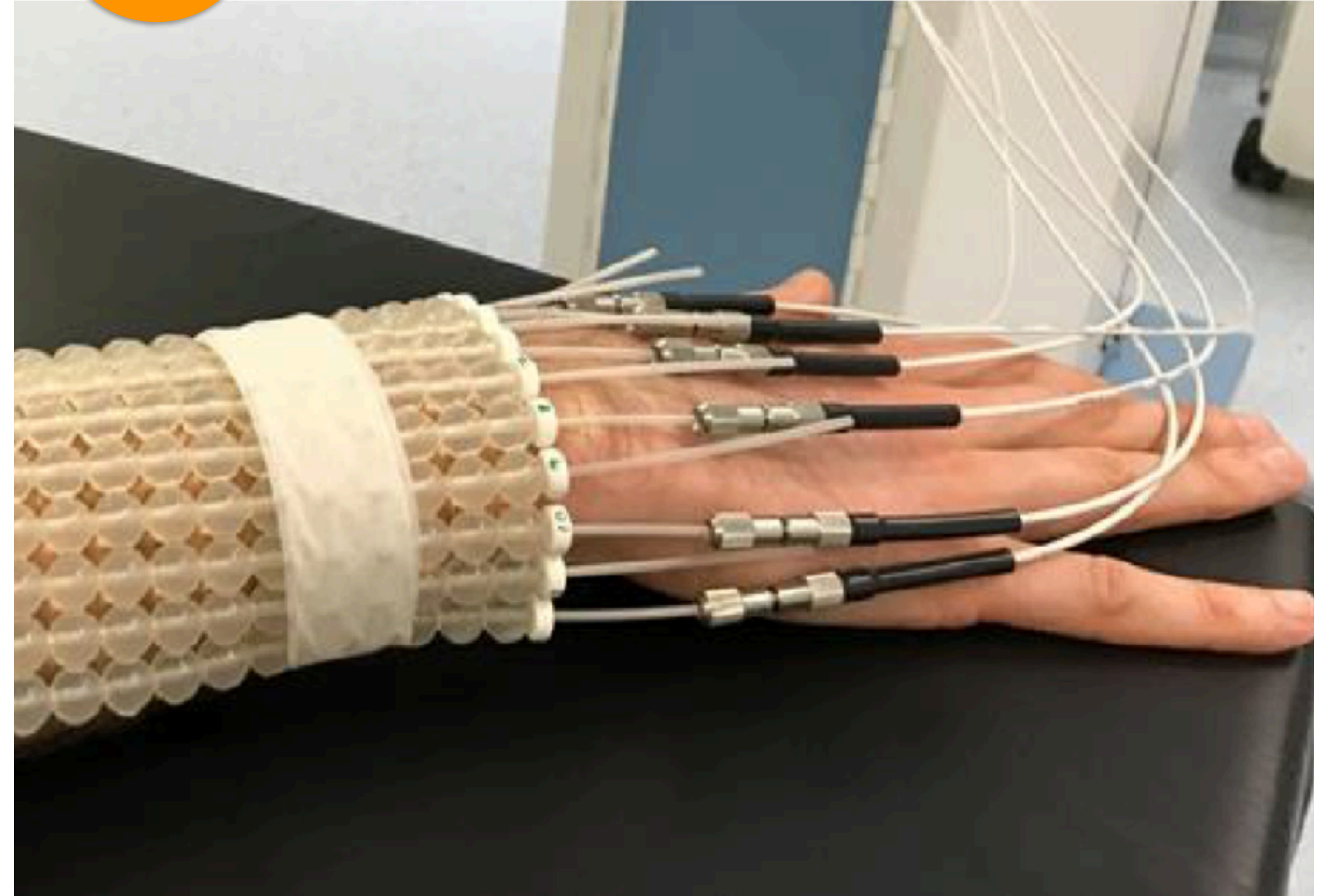

### 3 Data visualisation



### 4 Outcome prediction



**5 times**  
Costs reduction



**50%**  
Time save for  
doctor



**3 times**

Faster patient  
recovery



# World Wide opportunity

**110 b eur**

**TAM**

**+17 600 hospitals**  
**156 countries**

**+2 b eur**

**SAM**

**+7000 hospitals**  
**in EU, US**

**0.3 b eur**

**SOM**

**+1100 hospitals**

Costs reduction

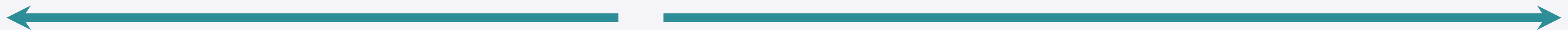
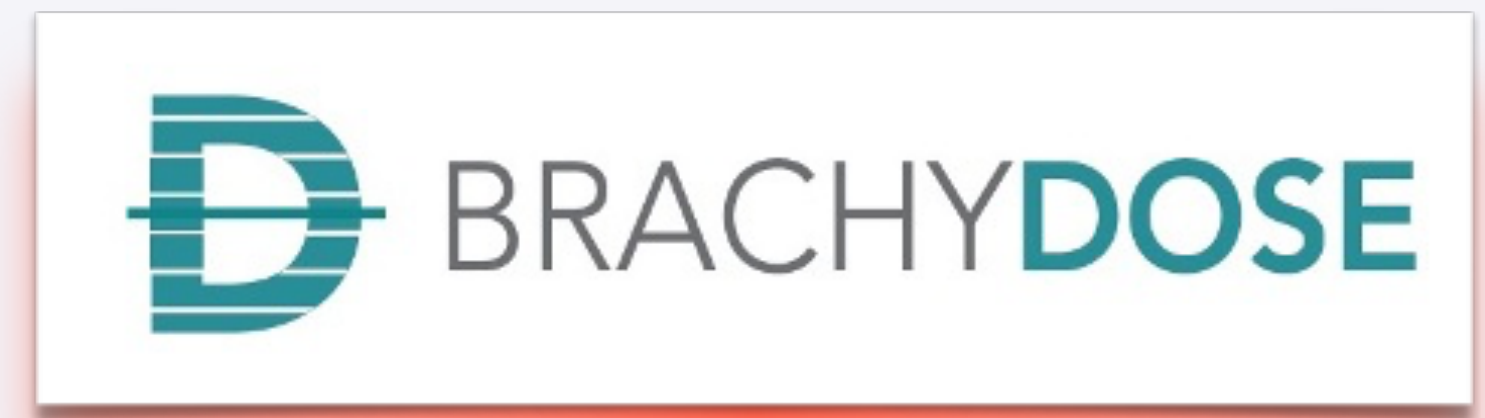

Time saving

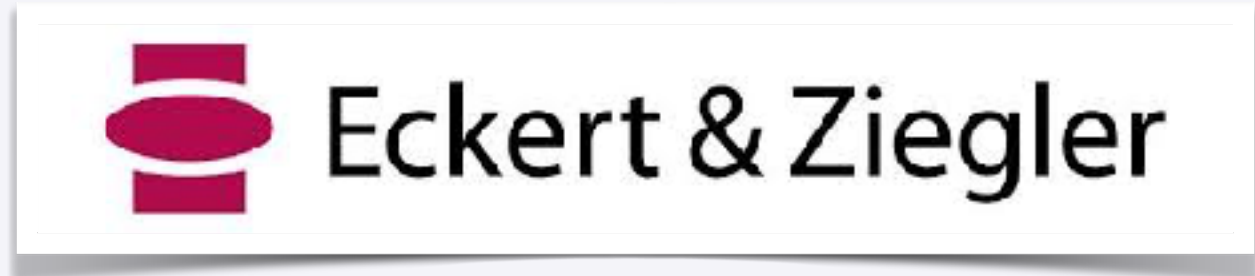

# Consumables

Sensors

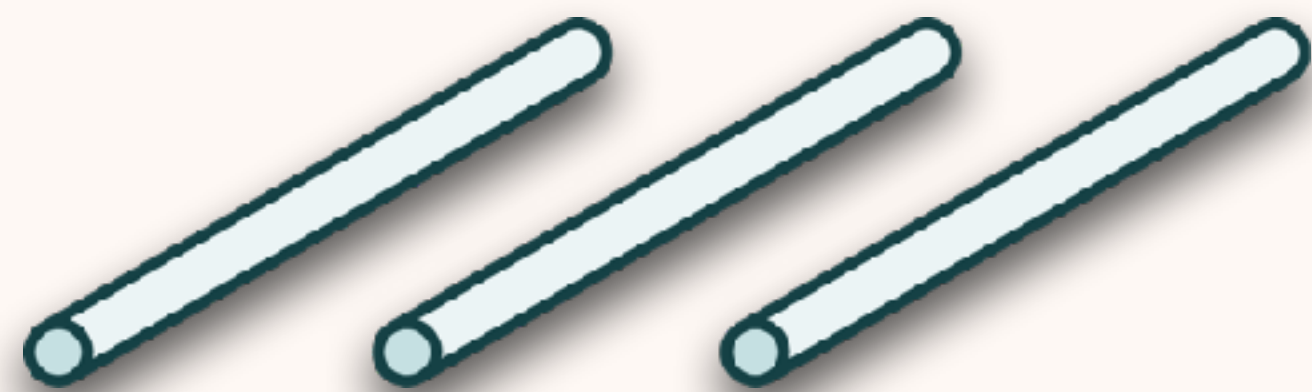

**20 eur/unit**

# Hardware

Scanner

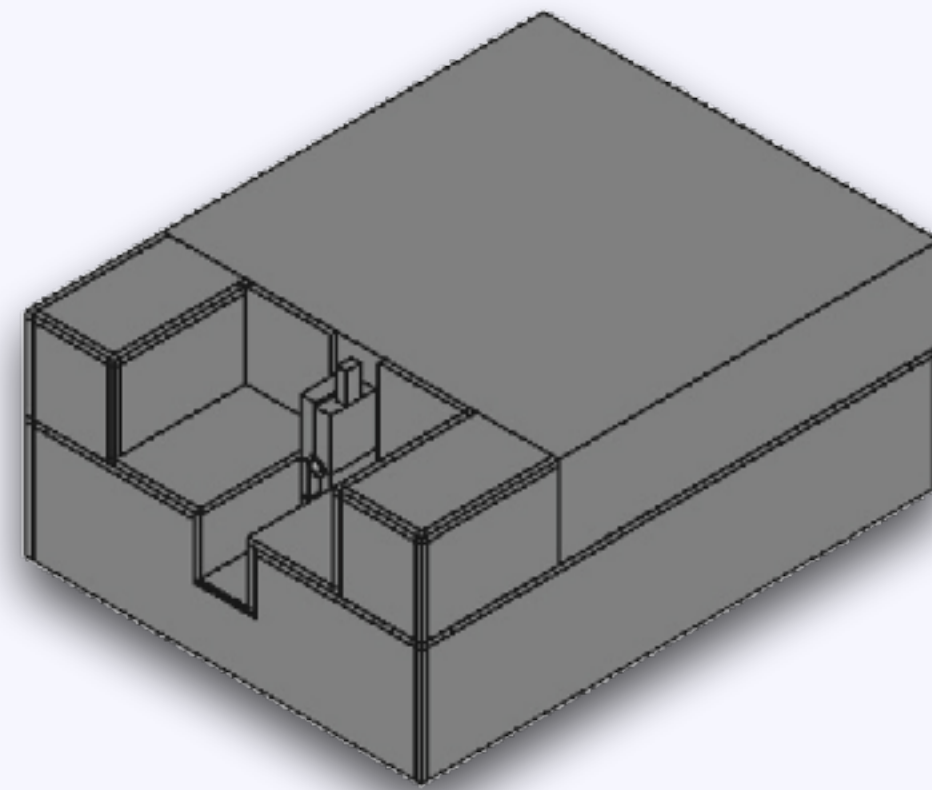

**5000 eur**

# Software

Licenses



**1500 eur/av.  
package**



# Startup Team



東京工業大学  
Tokyo Institute of Technology



## **Rimas Šeperys**

Co-Founder, Chief Engineer

+10 y in medical device engineering

## **PhD Neringa Šeperienė**

Co-Founder, CEO

+10 y in medical physics, clinical tasks

## **Dainius Bernatavičius**

Logistics and sales

+7 y in devices and sensors sales

## **Karolina Vaičiūnaitė**

+7 y in medical data + SQL

## **Živilė Ilginytė**

+5 y in data analysis

## **MD PhD Aušvydas Patašius**

Oncology and clinical trials expert

+10 y in radiotherapy

# Advisors and partners

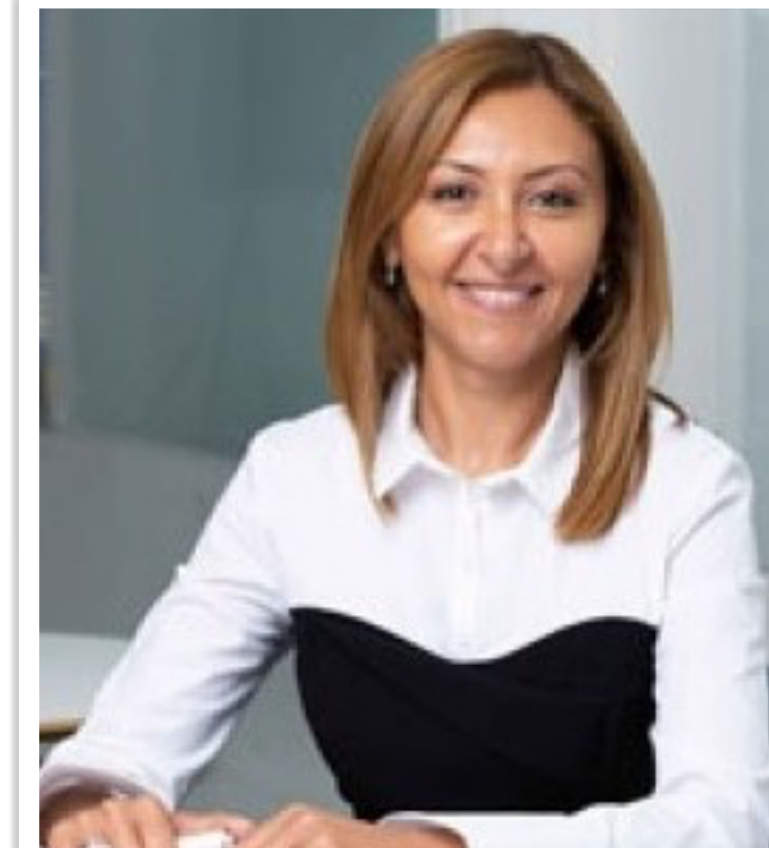

**Blandine Hirtz**

Clinical  
development

**Dr. PhD Jonas**

**Venius**

Radiotherapy expert

**Rouzet Agaiby**

Hardware  
development

**Laetitia Tournebize**

France market  
expert

**Dr. PhD Eduard  
Gerškevičs**

Radiotherapy  
expert

**Golo von Basum**

Mentor, German  
market expert



# Already attracted

Grants 200 k eur

Clinical partners

Prize from VC



HEIDELBERG  
UNIVERSITY  
HOSPITAL

Partnership



# Milestones

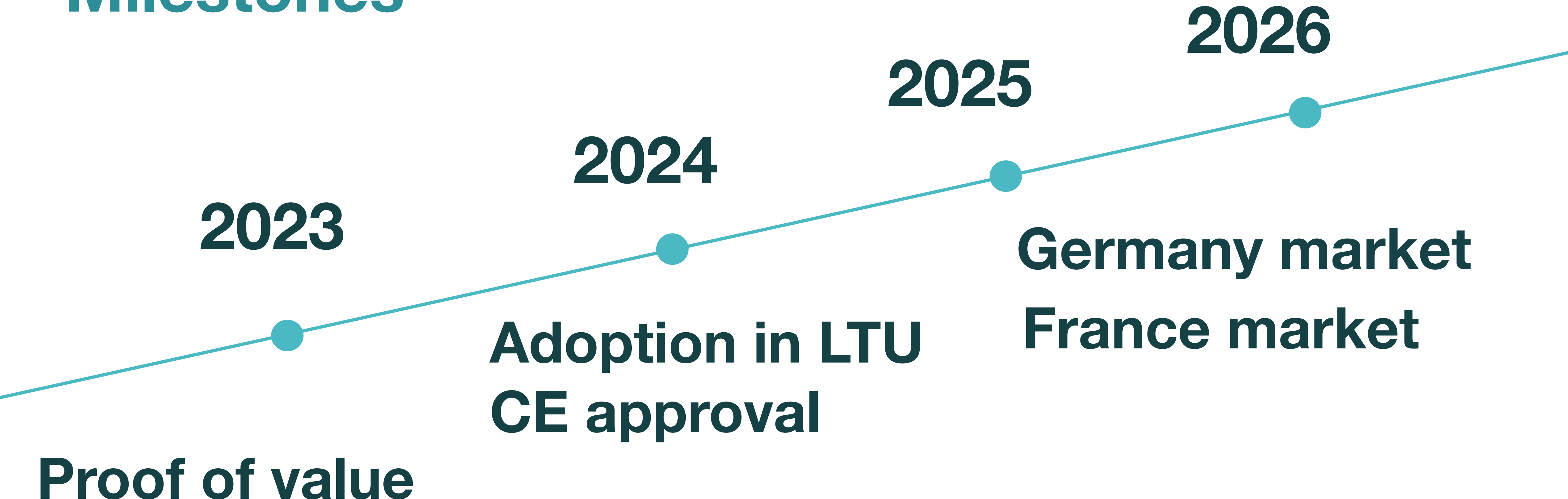

**Proof of value**

**Internal 150 M  
eur net revenue**

**External case 770 M  
eur net revenue**

# Looking for

# 500 k eur to:



10 hospitals in GER



EIC Accelerator Grant of 4 M eur



# World without cancer treatment errors

Neringa Šeperienė, CEO co-founder

[neringa@brachydose.com](mailto:neringa@brachydose.com)

[www.brachydose.com](http://www.brachydose.com)

+370 611 34592

